

Seitenansicht

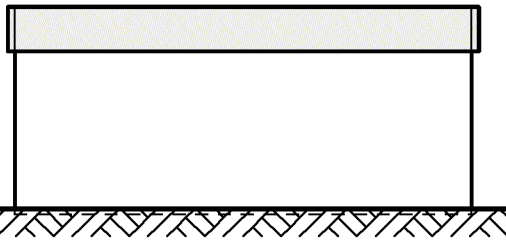

Längsschnitt

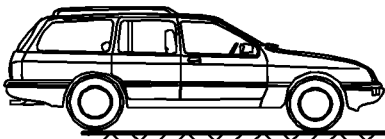
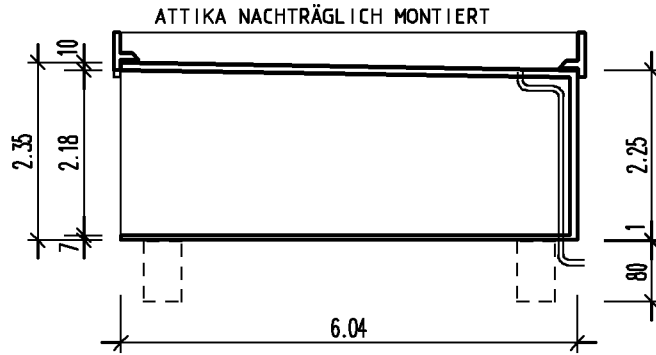

Vorderansicht

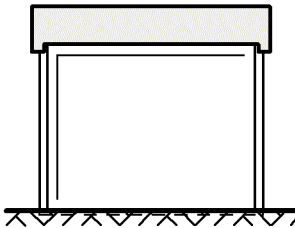

Querschnitt

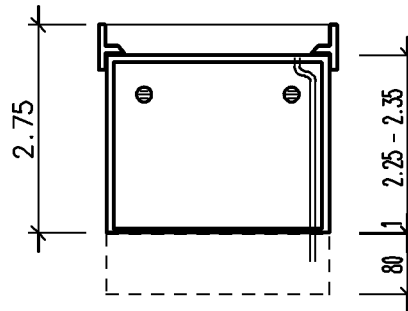

Grundriss

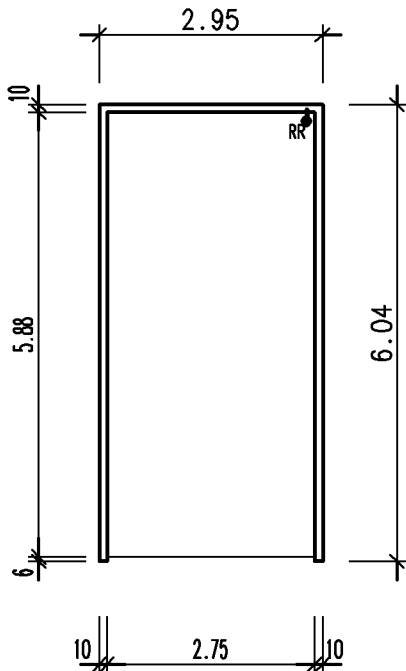

Gründung

gem. Typenstatik

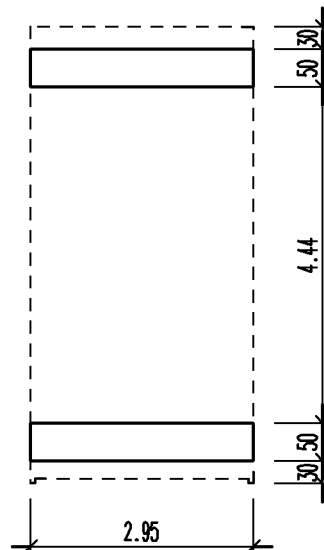

Bauherr

·
·
·

Bauvorhaben

·
·
·

Auftrag
Stand: 19/11/02 Dr.

Entwurfsverfasser

Nutzfl.: 14.26 qm
umb.Raum: 48.99 cbm

Garage Typ K

M. 1:100